

NOTICE: Unprecedented increases in steel prices have forced us to add a temporary surcharge for some products. Check with us for current prices.

2011-1

SEE PAGE 49

For Order Form & Terms

NEW-See Suture, Catheter, Sterile Wrap, Carts (pgs. 22-23)

EDGE CO

• Materials Handling • Central Supply • Maintenance/Safety • Housekeeping • Laundry



Folding Privacy Screens

#2900 - 3-Panel - Standard Size Screen

- Folded width: 19"
- Extended length: 50"
- Height: 68"
- Shipping weight: 8 lbs.
- Self extinguishing white panels
- 3/4" aluminum tubing

#2901

With Wheels

\$149.99

\$169.99

See page 9 for more sizes

UTILITY CART



AS LOW AS \$189.99

INCLUDES BASKETS



Economy Plastic Service Cart

ORDER NOW while supply lasts

Features:

- 330 lb. maximum capacity.
- Shipped KD, boxed.
- 2 swivel and 2 rigid 5" non-marking casters.
- 2" deep top and bottom trays.
- Optional 3rd shelf - #270496 \$29

Size: 16"w x 30"d x 33"h

Only \$99.99



#270494

Steel Econo Cart

Emergency - Instrument Medication Patient

Features:

- Overall size: 34"x20"x35"H
- Wrap-around bumper
- 4" wheels (2 w/brakes)
- 5 Drawers: 22"x17" (1) 2"H, (2) 4"H, (2) 6"H
- Color: red w/black molded top
- For added security, simply slide steel security bar along drawer fronts and attach padlock or ties (not included) at bottom
- Aluminum drawer pulls
- Ships Truck - 85 lbs.

\$279.99

Each



Cart Cover \$69.95

Model No. 345

Features:

- Triple chrome plated steel cart.
- Overall size 18"x27"x36"H with 3" casters.
- 24 1/2"x14 1/4" Light grey polycoated, rust resistant wire baskets.
- No assembly required.

Cat. No.	Description	Price
233-6	Cart w/2 - 6" Deep Baskets	\$189.99
233-12	Cart w/2 - 12" Deep Baskets	209.99
233-612	Cart w/1 - 6" & 1 - 12" Basket	199.99
233CC	Nylon Cart Cover	\$69.99

NEW



#18192



Cart MOC Cover \$69.95

NEW MOBILE ORGANIZER CART

Great for Instruments, Sterile Goods, Treatment Items

- Molded Plastic Drawers
- Easy clean Laminate Top
- 4" Wheels (2 Locking)
- Black HD Steel Tubular Frame: 17"W x 19"D x 44"H
- Ships UPS/FEDEX - Easy assembly

Overall Sizes:

Model #	Standard Drawers 12 1/4"W x 16 1/4"D	Price
12190	(9) 3" High Drawer	\$268
12243	(1) 3" High; (4) 6 1/4" High	252
Model #	Large Drawers 18 1/4"W x 16 1/4"D	Price
18192	(9) 3" High Drawer	\$299
18143	(1) 3" High; (4) 6 1/4" High	\$291

Other Sizes Available Specify Drawer Color: Light Gray, Dark Gray, Red, Yellow, Green or Blue. Clear Drawers available P.O.R.

Economy Laptop Station

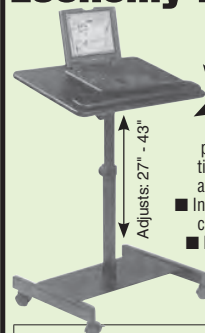

- Ergonomic, fully adjustable laptop station adjusts to the right height every time.
- Adjust from 27" to 43" with a positive tilt of 30° and a negative tilt of 25° to accommodate any user.
- Includes padded wrist rest for comfort and 2" casters for mobility.
- Black laminate top with black frame.
- UPS.

\$149.99

Model #	Dimensions	Weight
40362	27" - 43"H x 23 1/2"W x 18"D	25 lbs.



EDGE CO • P.O. Box 338 • Little Ferry, N.J. 07643 • (201) 945-5660 • Fax (201) 945-5966
TOLL FREE 1-800-833-4326 or 1-800-8-EDGE CO





Medical File Cart



- Overall dimensions: 26"W x 16"D
- Shelf width and depth: 24"W x 13 1/2"D
- Clearance between shelves: 11"
- Four rubber casters - 3" in diameter; 2 locking
- Steel gauge: 20 gauge shelf and 18 gauges legs
- Available in Platinum
- Made in the USA
- 2 Dividers per shelf

#5429

#5425 - Dividers (Pack of 3) ... \$19

#5428 (3) Shelf - 39" High

\$299.95 (UPS)



Cart Cover

#CC

\$79.95

#5429 (4) Shelf - 51" High

\$389.95 (Truck)

Sloped Shelf Cart With 6 Dividers



Cart Cover

5414CC

\$69.99



- Item dimensions: 26"W x 16"D x 41 1/2"H
- Three sloped shelves hold books, binders, file folders
- 12" clearance between shelves
- Four 4" casters
- Metallic Silver
- Easy assembly

#5414

\$289.99



Two-Shelf File Carts

Move files around the workplace on one of these easy-to-manuever carts. Full-width shelves provide plenty of room for folders and other office supplies. Includes two removable dividers and four casters (2 locking). Ships unassembled. **Color: Platinum.**

A. Low-Profile Cart. Fits conveniently under table tops, counters, or desks. 24"W shelves.

5421 - Low-Profile Cart. 26x16x27". Wt. 42 lbs.

Net each **\$199.99**

B. Slant-Shelf Cart. (Not shown). Designed for end tab folders and better visibility of cart contents. 30"W shelves.

5422 - Slant-Shelf Cart. 32x16x30 1/4"H". Wt. 46 lbs.

Net each **\$209.99**

C. Tambour Door Cart. Locking tambour door secures files. Includes two keys. 24 1/2"W shelves. Complies with federal HIPAA regulations.

5424 - Tambour Door Cart. 26x16x43". Wt. 45 lbs.

Net each **\$299.99**

5425 - Dividers. Pack of three dividers.

Net each **\$19.00**



Cart Cover

\$79.95

Storage Baskets & Racks



STORAGE BASKETS

Gray vinyl coated utility baskets. Can be wall mounted for easy access. Hardware included.

2250 - 19 1/2" x 6" x 4 1/2" deep. **\$25.70 ea.**
(Min 3 pcs.)

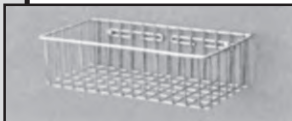

2255 - 15" x 7" x 3 3/4" deep. **\$23.75 ea.**
(Min 3 pcs.)



BLOOD PRESSURE CUFF BASKET

2200 - Adjustable to accommodate any IV stand. Gray vinyl coated. Mounting Hardware included.

(Min. 6 pcs.) **\$17.50 each**

2201 - Wall mounted. Very convenient. Gray vinyl coated. Mounting Hardware included.

(Min. 6 pcs.) **\$18.95 each**
7"L x 3"W x 7"D.

Special Purpose Cart



**ADJUSTABLE SHELVES
FLAT OR SLANTED**

**Mobile Space Saving
20"W x 17"D x 56"H Cart**
Unit shipped complete with four easy to install adjustable shelves and four 3" casters.

(2 Locking). White epoxy. 1 per carton. Shipped set-up via UPS

2056AB **\$239.70** Ea.



Cart Cover

#ABCC

\$79.95

Extra Shelf #2056SH **\$19.99** Ea.

EDGE CO STOOLS

Screw-Type and Pneumatic Stools for Exam Room, Hospitals or Lab.

Value priced adjustable examination stools in screw or pneumatic design provide a choice for almost all requirements. The screw adjustable models are all welded construction and feature legs constructed of chrome plated 1" OD x 14 gauge tubular steel and a solid steel height adjustment screw. Height adjustment range is 19" to 25". The stools have a 13-1/2" seat diameter and feature 4" polyfoam for comfort.

The pneumatic model features a stable 5-leg base design constructed of die cast aluminum. It has a 16" seat diameter, a smooth operating gas cylinder lift mechanism operated by a

convenient semi-ring under the stool. Stool height adjustment is 18" to 25" (nominal).

All stool models are covered in durable, black Naugahyde®. All models feature non-conductive, twin wheel casters for ease of movement.

Model Number	Description	Price		
		1.5	6-11	12+
11000-1	Pneumatic Stool, 5 legged die cast base.	\$199.95	\$179.95	\$159.95
11051-1	4-leg Screw-type Stool, with round foot ring.	112.50	99.99	89.99
11052-1	4-leg Screw-type Stool, with square foot ring.	99.95	89.95	79.95



TWO-STEP STOOL

- Extra-wide tops
- Rubber tops for safety
- Chrome-plated, reinforced base
- 26 1/2" L x 17 1/4" H x 17 1/2" W
- 600 lbs. capacity

T-6842 **\$139.99**

TWO-STEP STOOL WITH HANDRAIL

- Same as T-6842 with angled handrail
- 26 1/2" L x 17 1/4" H x 17 1/4" W
- 43" high at highest point

T-6850 **\$179.99**



11000-1



11052-1



11051-1



\$349.90

Model No. 638

LABORATORY STOOL

- Pneumatic Height Control Lever
- 5-Leg Base
- Dual Wheel Nylon Casters
- Adjustable Foot Ring
- Adjustable Backrest
- 3" Foam Padding
- Easy Clean Vinyl Upholstery
- Height Range 23"-30"

21830B

\$289.99

EDGE CO 5-LEG ALUMINIUM BASE STOOLS

The finest line of stools in the industry with more styles and variety than ever before. The large 16" diameter seat with 4" of solid foam padding adds extra comfort. Convenient and easy best describes one hand pneumatic height adjustment. The stable 22" 5-point base and twin-wheel carpet casters allow easy movement.

**Optional:
Foot Ring No. TR1
\$56.75**



21830 **\$231.10**

Catalog No. 21830 Stool

- Pneumatic height adjustment: 18" to 24"
- Seat: 16" Diameter, 4" polyfoam cushion.



ECONO MODEL \$159.99

Catalog No. 21400

- Same specs as 21830 except with a screw-type manual height adjustment.



Catalog No. 21830B Stool w/23378 Back Rest

- Same specs as 21830 with the addition of a back rest. Back Rest: 9"x17" contour.

EDGE CO STEP STOOLS

Sturdy Built Step Stools. 300 lb. Capacity.

The new EDGE CO step stools are ideal for examination rooms, X-ray and any other area where sturdy support is required. The stool legs provide 9" of height and are constructed of 18 gage tubular steel in design, with a long lasting chrome plated finish. The top is all steel with a skid resistant mat. The handrail is made of 7/8" steel tubing with a durable chrome finish and is 34" in height from top of rail to the floor.

#RT - Rubber Tips (25 Pcs. Min.) - **\$2.50 Each**

Model Number	Description	Price		
Size	14 1/4" W x 11 1/4" D	1-5	6-11	12+
11200-2	Step Stool	*\$36	\$32	\$29
11220-0	Step Stool with Handrail	59	54	49

* 11200-2 (min. 2 pcs.)

Specifications subject to change. All dimensions are normal.



11220-0

Platform size
14 1/4" x 11 1/4"



ERGONOMIC SIT-STAND STOOL

LEVER ALLOWS STOOL TO BE EASILY ADJUSTED

- Ideal for use in front of workstations, behind counters or on assembly lines.
- Matte black tubular steel base.
- Four strong nylon anti-slip glides provide stability on most flooring.
- Ergonomically formed, padded polyurethane seat swivels 16" in either direction.
- Seat height adjustable from 22-3/4" to 32-3/4" for workers of almost any size.

Relief for workers who can't sit down on the job

Model # 2092N
\$269.99

CUSTOM CART COVERS

ALL CART COVERS ARE CUSTOM MADE TO YOUR SIZE SPECIFICATIONS

THE PRICES BELOW ARE FOR PRICING EXAMPLE ONLY.

Dimensions For Price Purposes W x L x H	200D Nylon	400D Nylon	Flame Resistant Vinyl Staph-Chek	200D Flame Nylon	10 Gauge Clear Vinyl
UP TO 18" x 48" x 54"	\$65.00	81.00	99.00	86.00	109.00
UP TO 18" x 48" x 62"	69.00	87.00	107.00	91.00	111.00
UP TO 18" x 48" x 72"	78.00	94.00	117.00	100.00	116.00
UP TO 24" x 48" x 54"	69.00	87.00	107.00	91.00	112.00
UP TO 24" x 48" x 62"	75.00	92.00	113.00	97.00	119.00
UP TO 24" x 48" x 72"	85.00	103.00	127.00	109.00	135.00
UP TO 24" x 60" x 54"	75.00	91.00	115.00	97.00	121.00
UP TO 24" x 60" x 62"	82.00	101.00	124.00	107.00	133.00
UP TO 24" x 60" x 72"	91.00	113.00	136.00	118.00	139.00
UP TO 24" x 72" x 72"	114.00	128.00	156.00	130.00	154.00

No minimum orders! Covers are all custom made and no returns are accepted. Please call for assistance if unsure!

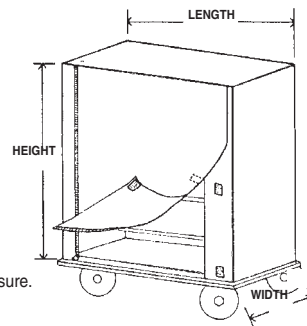

FEATURES

- Full flaps
- Choice of heavy-duty zippers or velcro closure.
- Reinforced corners.
- Double needle construction.
- Custom manufactured to your order.
- Use on linen carts, central supply carts, lab carts, medicine carts, food carts, etc.

We'll custom design and make any cart cover to your specifications.

We have seven time-tested materials in a variety of colors and styles to choose from:

- 200 D Nylon — durable (red, blue, green yellow & white)
- 400 D Nylon -- Pack Cloth (red, blue, green, yellow & white)
- STAPH CHEK: (blue, green, white or mauve)
- 200 denier flame resistant nylon (White-only)

To figure out cost for a different size, go to next larger size. All materials are preshrunk—allowance made for proper fit.



SUPER ECONOMY Adjustable Height Stool

Includes polyurethane seat and backrest, 18" diameter foot ring, pneumatic height control, height- and depth-adjustable hinged backrest. Height adjusts 23" to 33." Includes wheels.

#942CD

\$159.99



NEW

E21922

\$159.99

Extra Tall Chrome Base Stool

- Non-Adjustable round foot ring
- 2" Rubber wheel, ball bearing casters
- Screw type height adjustable
- 14" Seat diameter
- 23" - 29 1/2" Height range



6142

\$59.95

Bariatrics Foot Stool

- Chrome-plated base
- Reinforced "X" base construction
- Rubber tread top for safety
- 600 lbs. capacity
- Rubber feet
- Size 14 1/4" L x 11 1/4" W x 9" H
- Model No. 6142



Triple Wire Glove Box Holder #305375

NEW!

Deluxe Wire Glove Box Holder #305380

Wire Glove Box Holders Ideal for Infection Control!

Order Now!

Economy Triple Wire Glove Box Holder holds three glove boxes. Glove Box Holder accepts one box horizontally or 2 boxes vertically.

- Very strong but lightweight
- Models mount horizontally or vertically

Item #	Description	Dimensions	Minimum	Price/Ea.
305325	Glove Box Holder	10 1/4" W x 4H x 3 D	3	\$12.00
305375	Economy Triple Wire	11 1/2" W x 16H x 4 1/2 D	4	\$27.00
305380	Deluxe Triple Wire	17W x 11 1/2 H x 4 1/2 D	4	\$37.00

DELUXE LARGE-CAPACITY



LINEN CART

- Fire-Proof, All Steel
- 5" Swivel Casters
- 4 Infinitely Adjustable Shelves
- 1000 Lb. Capacity

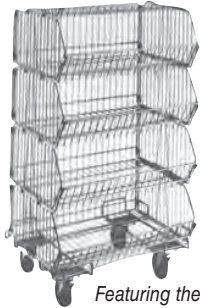

OPEN WIRE VISU-BIN CART

Featuring the Quick-Easy Access

The slanted hopper front makes selection easy. Bright Zinc plated open wire baskets reduce dust and dirt accumulation and allow easy inventory control, just stack baskets on top of each other to the required height. Optional dividers attach securely to create a variety of compartment sizes: Basket Size 48"L x 20"D x 10"H. Ships KD, easy assembly. Includes 3" casters.

No.	Baskets	Height	Price
48-5	5	56"	\$299.99
DIV-10 Dividers			\$6.99 ea.
48CC Cart Cover			\$79.99



SHELF COVER



Shelving shall be made of carbon steel, zinc chromate plated, and finished with a baked-on clear coating to protect against rusting. Best of all, "It's A Snap" to assemble shelving because of its improved posts and shelf supports. The posts are grooved and numbered in one-inch increments, and the one-piece hinged shelf supports instantly align themselves at the desired height and then *snap* into place. Installation is simple and fast; one person can assemble units in minutes with no tools needed.

Model No.	Shelf D x W	Overall Ht.	Wt. Lbs.	SALE PRICE Each	4+
P70-336C	18" x 36"	70"	70	\$237	\$225
P70-348C	18" x 48"	70"	86	263	249
P70-360C	18" x 60"	70"	106	291	276
P70-372C	18" x 72"	70"	130	346	329
P70-536C	24" x 36"	70"	82	267	253
P70-548C	24" x 48"	70"	98	303	288
P70-560C	24" x 60"	70"	118	348	330
P70-572C	24" x 72"	70"	142	398	378

LEDGES FOR FRONT, BACK OR SIDES - 6" high. Prevents items from falling off shelf.

Length	Stock No.	Price	Length	Stock No.	Price
18"	580	\$9.80	48"	586	\$16.90
24"	582	11.30	60"	588	17.25
36"	584	12.95	72"	590	18.80

SHELF DIVIDERS - 9" High

H x D	Stock No.	Price
9"x18"	563	\$11.45
9"x24"	564	16.70

3-SIDED STOCK TRUCKS

Open-wire design permits easy visual checks from all sides. Zinc-3 sided stock truck has back and side enclosures to keep packages from falling during cart movement. Shelves adjust on 1" increments. 4-swivel 5" casters. 70"H. 800 lb. capacity.



Stock No.	Shelf WxD	Weight	SALE Ea.
689A	36" x 24"	124 lbs.	\$459.90
690A	48" x 24"	144 lbs.	512.50
691A	60" x 24"	170 lbs.	565.80
692A	72" x 24"	190 lbs.	599.97

POLYETHYLENE SHELF COVERS

No.	Size	Price	No.	Size	Price
1836SPC	18" x 36"	\$37.00	2436SPC	24" x 36"	\$39.00
1848SPC	18" x 48"	48.00	2448SPC	24" x 48"	51.00
1860SPC	18" x 60"	50.00	2460SPC	24" x 60"	53.00
1872SPC	18" x 72"	52.00	2472SPC	24" x 72"	54.00

Utility Table

Single drawer with double-walled front, 2" casters, painted steel top and guardrails.

#6883

\$489.25 ea

Specifications:

20"W x 32"H x 16"D

Weight: 45 lbs.

Shelf: 15 $\frac{3}{8}$ "W x 19 $\frac{3}{8}$ "L x 1 $\frac{3}{8}$ "D

Drawer Size: 12 $\frac{7}{8}$ "W x 13 $\frac{7}{16}$ "L x 3 $\frac{5}{16}$ "D



BASKET CART

Eliminates Stooping and Bending

An easy-rolling, compact cart with a high basket that's easy to load or unload. For linen, bottled goods or maintenance supplies. Sturdy tubular frame and wire basket. This lightweight cart is easy to maneuver on 5" dia. wheels. Chrome plated.



No. 1000E **\$139.99**

Overall Size: 27"L x 22 $\frac{1}{2}$ "W x 27 $\frac{1}{2}$ "H.

Basket Size: 27"L x 22 $\frac{1}{2}$ "W x 11"H.

Basket Liner No. 1141 **\$39.90** Cap No. 1131... **\$25.99**

No. 2000F **\$169.99**

Overall Size: 33"L x 19"W x 32"H.

Basket Size: 33"L x 19"W x 15 $\frac{3}{4}$ "H.

Basket Liner No. 1241 **\$49.99** Cap No. 1231... **\$29.99**

NEW! STEP-ON CONTAINERS

Tough Dur-X resin doesn't chip, dent or rust. Step-on pedestal allows for no-hands operation. Ideal for disposing of infectious materials. Tight fitting, overlapping lid equipped with a deodorant block holder. 23 Gallon container has steel wheels.

No.	Description	Size	Color	Price
6143	8 gal.	16" x 16" x 18"H	Beige, Red, White	\$99.99
6144	12 gal.	16" x 16" x 24"H	Beige, Red, White	111.90
6145	18 gal.	16" x 20" x 26H	Beige, Red, White	127.99
6146	23 gal. Mobile	16" x 20" x 33H	Beige, Red, White	163.90



Factory Mutual System Approval



Rubbermaid

Fire Resistant Wastebaskets

With their attractive design and complementary colors, Rubbermaid® fire resistant wastebaskets add to the decor of any office environment.



Rubbermaid® fire resistant wastebaskets were tested and listed by Underwriter's Laboratories. These waste containers have the ability to contain burning paper without melting or contributing fuel to the container contents. Order Ctn. Qty. only.

No.	Description	Color	Size	Ctn. Qty.	Sale Price (ea.)
2540	7 qt.	LB	9 x 6 x 11H	6	\$19.99
2541	14 qt.	LB, LG, BL	11 x 8 x 12H	6	27.95
2543	28 qt.	LB, LG, BL	14 x 10 x 15H	6	37.90
2544	40 qt.	LB	15 x 11 x 20H	4	49.90

Colors: LB (Light Beige), BL (Black), LG (Light Gray)

Locking Workstation/Cart/Cabinet

Combines storage space, lock-up security and contemporary styling. Constructed of heavy gauge steel with gray and black scratch resistant powder coat finish for durability. Full length piano hinges and two point locking system help ensure security. Steel reinforced top plastic shelf has 1/2" retaining lip and molded-in safety push handle. 4" rubber wheel non-marring swivel casters - two locking. Ready to assemble. 5 Year Limited Warranty.



#3140

#3134

450 lb. capacity



Ships



Model No.	W x D x H	Cap. Lbs.	Doors	Interior Shelves	Price
3134	24" x 18" x 34"	350	1	1	\$229.99
3142	24" x 18" x 42"	350	1	2	\$269.99
3140	32" x 24" x 44"	400	2	1	\$295.99

OPTION.... 3 OUTLET SURGE PROTECTED POWER STRIP WITH 15' ELECTRIC CORD...\$34

I.D. Step-Ons

Big Sale! Big Sale! Big Sale! **ORDER NOW!**



Square models are equipped with poly bag Retainer Bands.

FIRE SAFE STEP ON WASTE CAN

Choice of Painted or Stainless Steel!

Self closing, heavy gauge steel, step-on receptacles will contain and extinguish flames in minutes; meets federal flammability standards (CID-182), are UL Listed/FM Approved fire-safe self-extinguishing and California State Fire Marshall Listed. Tight-fitting foot operated lid for no hands operation, provides excellent sanitation and odor control. Permanently attached folding retainer bands secure polyethylene disposable bags neatly inside for added convenience and cleanliness. Lid restrain mechanism protects walls and equipment. **PAINTED STEEL** models have white or red baked-on enamel power coated finish. **Specify color suffix; White (WH), Red (RD) or Stainless Steel (SS).**

Model	Gallon Capacity	Dimensions W x D x H	Price Each	
			Paint	SS Steel
ST7	7	12" x 12" x 17"	\$129.00	\$196.00
ST12	12	12" x 12" x 23"	139.99	235.00
ST24	24	15" x 15" x 30"	149.99	305.00
ST40	40	19" x 19" x 30"	177.00	399.00

Model No.	BILINGUAL LABEL	Price Each	Sale
CL1	Bio Hazard/Peligro Biologico	99.99	\$5.99
CL2	Soiled Linen/Ropa Sucia	9.99	5.99
CL3	Trash Only/Basura Solamente	9.99	5.99
CL4	Infectious Waste/Basura Infecciosa	9.99	5.99
BP-1	Bio Hazard	99.99	5.99

(Minimum Order 10 Labels, Mix or Match)

WASTEMASTERS™

Heavy gauge fire safe steel construction. Meets OSHA Requirements. Hinged top with self closing, springless dual entry disposal opening door opens 90° for access to retainer bands that hold poly bags neatly inside. Choose optional Germ-Fighter® rigid plastic liner models for germ and odor control and UL / FM Approval. Durable White Uni-Koat® powder coated finish or Stainless Steel.



Add SS To Model No.

Model No.	Dimensions	Description	White	Stainless
T1414RB	14" Sq x 26" H	14 Gal. Swing Top	\$159.00	\$248.00
T1414PL	14" Sq x 26" H	Swing Top w/ 10.5 Gal. Germ-Fighter®	199.00	269.00
T1424RB	14" Sq x 35.5" H	24 Gal. Swing Top	169.00	270.00
T1424PL	14" Sq x 35.5" H	Swing Top w/ 16 Gal. Germ-Fighter®	199.00	325.00



Round Tops

Heavy gauge fire safe steel construction. Reinforced self closing, stainless steel door controls odors and meets OSHA Requirements. Non-corrosive stainless steel base ring protects floors. Recessed hand grips permit easy lift off for emptying. Complete with a galvanized steel liner. Durable White Uni-Koat® powder coated finish.



Hands Free StepMaster with foot pedal operation

Model No.	Description	Dimensions	Price
R1530EGLWH*	12 Gal. Round Top	15" Dia x 30" H	\$149.00
R1536EGLWH*	15 Gal. Round Top	15" Dia x 36" H	159.00
R1536STEGLWH	15 Gal. Step Master	15" Dia x 36" H	199.00

* Indicates UL Listed/FM Approved Fire Safe Self Extinguishing.

Model 70



Model 10

Tall and Terrific Fire-Safe

The Model 70 is all-steel, fire-safe, and features solid-ribbed constructions for puncture resistance. The Model 70 also features fire-safe steel construction with color-coordinated vinyl bumpers and no-mar polyethylene feet.

- 30" High
- Specify Color - Gray, Black, Almond

No Broken Cartons.

Model	Capacity	Size	Price Ctn./3 Pcs.
70	24 Gal.	21" x 11" x 30" H	\$229.00
10	20 Gal.	16" Dia. x 30" H	129.00



Steel Step-on Containers

- Full length galvanized steel with steel hinges; withstand heavy use
- UL listed, Factory Mutual approved; self-extinguishing
- Contoured lids maximize odor control
- Stainless steel legs feature non-skid plastic buttons to protect floors
- Galvanized liner included
- Specify: Red (R), White (W)

Order Labels Above.

Model	Gallon Capacity	D x H	Paint	SS Steel
ST3	3 1/2	11" x 17"	\$79.99	\$139.99
ST5	5	11" x 22"	\$99.99	—

Instrument Stands / IV Poles



**M-26
Mobile Instrument Stand**

- 4 leg heavy-duty design
- Rubber, ball bearing casters
- Chrome plated pole and frame
- Powder coated base with bumper ends - 23"
- Adjustable height 30"—49"

1-9	10+
\$129.90	\$99.99

**M-21
Single Post Mayo Stand**

- U-Shaped heavy chrome base
- Two ball bearing, rubber casters
- Chrome plated 18" x 22" base
- Adjustable height 31"—50"

1-9	10+
\$119.90	\$92.99

**M-25
Mobile Instrument Stand**

- Easy clean, nylon composite, 23" base
- Stable 5-leg base with dual nylon wheels
- Adjustable height 31"—50"

1-9	10+
\$124.99	\$96.99

**M-20
Mobile Instrument Stand**

- Stable, 5 leg aluminum 23" base
- Dual wheel casters
- Adjustable height 31"—50"

1-9	10+
\$139.90	\$109.99

**M-22
Double Post Mayo Stand**

- Heavy, rectangular 21" x 20" base
- Two ball bearing, rubber casters
- Adjustable height 34"—54"

1-9	10+
\$119.95	\$92.95

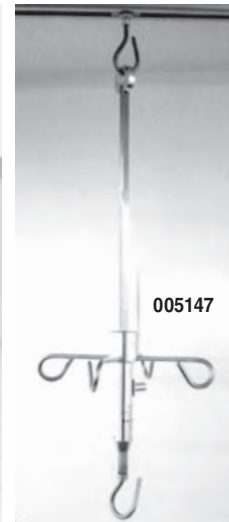
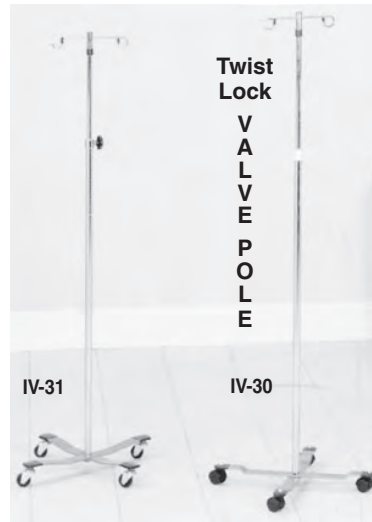

Hanging IV Station

- Attaches to standard cubicle curtain track
- Adjusts & locks anywhere on standard steel shaft - vertical adjustment 24" - 40"
- Traverses horizontally anywhere along track & locks in place
- Standard extensions available to accommodate up to 10' 6" ceiling height

\$199.97

CHROME POSTS

Model No.	Hooks	Base	Base Diameter	Caster	Height Range	Load Capacity	Price
IV-35	2	Aluminum	24"	5 Dual Wheel	50" — 90"	45 lbs.	\$109.90
IV-354	4	Aluminum	24"	5 Dual Wheel	50" — 90"	45 lbs.	112.90
IV-33	2	Epoxy/Steel	26"	6 Rubber	56" — 99"	45 lbs.	167.00
IV-334	4	Epoxy/Steel	26"	6 Rubber	56" — 99"	45 lbs.	205.00
IV-37	2	Nylon	24"	5 Dual Wheel	51" — 91"	45 lbs.	125.99
IV-374	4	Nylon	24"	5 Dual Wheel	51" — 91"	45 lbs.	122.99
IV-30	2	Epoxy/Steel	22"	4 Dual Wheel	51 1/4" — 94"	45 lbs.	49.99
IV-31	2	Epoxy/Steel	22"	4 Rubber	51 1/4" — 94"	45 lbs.	97.99
IV-314	4	Epoxy/Steel	22"	4 Rubber	51 1/4" — 94"	45 lbs.	99.25

NEW**NEW****NEW****NEW****NEW****Code #3400 - Secure Care™ Overbed Table**

- Durable Triple Chrome™ plated steel frame and base.
- Mar-resistant wood grained laminated top with vinyl edge molding
- Extra stability provided by four-point base.
- Simple one-touch adjustment to raise or lower table.
- Built-in column lock for added safety.
- Four 1-1/2" chrome hooded ball casters provide smooth rolling motion.
- Height: 28" to 45"
- Base: 15-1/2" x 26-1/2"
- Table Top: 15" x 30"
- Shipping weight: 27 lbs.

\$129.99**Folding Privacy Screen**

3/4" diameter anodized aluminum frame with stainless steel hinges. Panels are 6-mil. Bacteriostatic white vinyl. 68"H. Meets CAL 117.

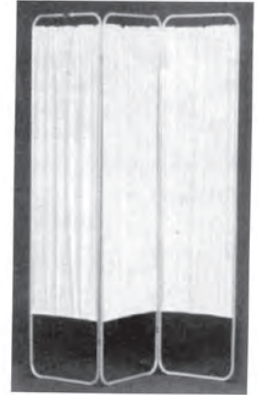

Model	Item	Price
#3900	Three panels: 31"W folded, 85"L extended.	\$199.99
#3901	With Wheels	224.99
#4900	Four Panel, 19"W folded 62"W extended	219.90
#4901	With Wheels	239.99

**Code #2702
Deluxe Exam Lamp
3-Conductor**

- Swivel mounted.
- Dual cool shade concentrates light with minimal heat build-up
- 3-wire grounded cord set with molded plug
- Optional: 4-leg Mobile Base
- Height adjustment: 49-1/2" to 72"
- Shipping weight: 12 lbs.
- 12" flexible arm
- 12 foot cord
- Base: 10 lbs.; 10-5/8" dia.
- Bulb: 10-40 watt (not included)

\$99.99Mobile Base Model T12 **\$119.99****Blood Drawing Chair**

- One piece plastic seat 17" x 16"
- Adjustable height arms 27" - 33"
- Double pivot arm rest
- All welded heavy duty frame

\$348

#6060-P

**Blood Drawing Chair
With Cabinet**Cat.
No.
8670

Adjustable armboard raised and lowered. 40" wide chair with armboard and storage cabinet (cabinet is 12"x9 1/2"x16"H). Chair is 32" high; seat is 18"W.

Cat. No. 8670

Description:
With 1 Arm & Cabinet**\$374.99****Code #1900 -
Stainless Steel Kick
Bucket with Frame**

- Capacity: 13 quarts
- Frame: Flat 1"x1/8" stainless
- Diameter: 14-1/2"
- Shipping weight: 14 lbs.
- All welded.
- Rubber coated, ss, conductive wall guard.
- Four 2" wheels, conductive

\$199.97**Extra Wide Blood Drawing Chair**

- Accommodates larger patient
- Padded & upholstered seat
- Adjustable height arms
- All welded heavy duty frame
- Seat - 24" wide
- OV-size
33"w x 23" x 35"h
- 450 lb. capacity

\$529

#575-XL

Specify: Blueridge, Hunter Green, Mauve, Royal Blue, Sand, Seafoam Green or Burgundy upholstery.

ROUND HAMPER STANDS WITH COVERS

- Chrome plated, welded tubular steel frame.
- Heavy-duty 2" swivel casters
- Heavy-duty chrome cover that closes automatically.
- Spring-loaded foot pedal for easy "hands free" opening and closing.

Cat. No.	Description	Std. Pkg.	Wgt. Lbs.	1-5	Price/Each 6+
5571	18" Round Hamper without Cover, 35"H	1	11	\$129.95	\$119.95
5572	25" Round Hamper without Cover, 36"H	1	24	\$169.95	\$149.00
5573	18" Round Hamper with Cover, 35"H	1	13	\$239.00	\$219.00



5571/72
Ships UPS



5573
Ships UPS

NEW! - 5573R with Red Cover Add **\$9.99**

STEEL TUBULAR HAMPERS



- The Ideal System for Linens or Waste Disposal.
- Heavy Duty Steel Frame is Chrome Plated for a Clean, Professional Look.
- Available with Hands-Free Foot Pedal
- Holds 25" Diameter Hamper Bags
- Fits Standard Disposable Ply Bags (35-40 Gal.)
- Durable, High Impact Plastic Lids Included.
- Rolls Easily with 4" Casters
(Foot Pedal Models Include 2 Locking Casters)



NEW! Color Lids Available - Color - Blue (B), Black (BK), Red (R), Yellow (Y) Add **\$25.00**

NEW! - Leakproof Hamper Bags #68; Color - Blue (B), Green (G), Mauve (M), White (W) **\$35** ea.

SINGLE STEEL TUBULAR HAMPER WITH FOOT PEDAL

21½" x 23" x 37" high. **682** **\$179.99**

DOUBLE STEEL TUBULAR HAMPER WITH FOOT PEDAL

39" x 23" x 37" high. **684** **\$259.99**

TRIPLE STEEL TUBULAR HAMPER WITH FOOT PEDAL

56½" x 23" x 37" high. **686** **\$349.99**

90" PRIVACY PARTITION - FAST!



Telescopic Curtain provides unobstructed privacy. Strong wall bracket. Rod telescopes out from wall 39" to 90" and can be positioned anywhere within a 180° arc. Powder coated. White vinyl curtain is bacteriostatic and flame retardant (NFPA-701, Small Scale). 72" High.

#340

Telescopic Curtain Set

\$129.99

Curtain folds flat to the wall or extends clear out to 90".

HAMPER STAND "SANITARY CAPS"



TOP-LOADING CAP
(Load linen through top slot)



LIFT-OFF CAP

Edgeco's Hamper Stand Caps are the easy and inexpensive way to cover your old hamper stands and comply with the standard set by the **Joint Commission on Accreditation of Hospitals**.

- Prevents odors and contamination.
- Fits any size from 18" to 25" (46 to 64 cm).
- Ties on cap attach to stand.
- Heavy duty nylon with shock cord for snug fit.
- Color: White.
- Two styles to choose from.

Cat No.	Description	Min.			Add 10% For Colors
		6 pcs.	12	36	
18015 NL	Top Loading Cap	\$13.99	\$10.99	\$6.99	Blue, Green
8000 NL	Lift-Off Cap	11.99	9.99	5.99	Yellow, Red